



EZIFOLD

Bi-fold door range

**6000
1000 SLIM
HERITAGE**

CONTENTS

Why choose aluminium?	03
Ezifold 6000	04
Ezifold 1000 Slim	05
6000 Profile	06
1000 Slim Profile	07
Ezifold Heritage	08
Heritage profile	09
Options & configurations	11
Colours & finishes	14
Custom made for you	16
Door thresholds	18
Safe & secure	20
Door handles	22
Fabrication	23



WHY CHOOSE ALUMINUM?

Renowned for its perfect combination of light weight and high strength, aluminum is the ideal material for sliding and folding doors, providing slim, elegant designs and outstanding performance.

With a life-span measured in decades rather than years, together with extremely low maintenance requirements, aluminum has become the perfect choice for home owners.

Maintenance for aluminium systems is simple and straightforward, with a routine 'wipe-clean' all that is required to keep the products looking their best. With no requirement for re-painting or re-varnishing, aluminium windows and doors will never fade, deteriorate or rust, even in harsh environments, or coastal locations.

With its sleek aluminium aesthetics, Ezifold is a sure-fire winner with any installer looking to offer their customers a stylish, modern design.

And thanks to the high-tech manufacturing expertise of Chigwell Window Centre, Ezifold isn't just quick and easy to fit – it comes with a 25-year colour guarantee, and a 10-year hardware guarantee too.

The Ezifold bi-fold door provides high specification and standards that meet or exceed industry requirements.

These include:

- Large bi-folding door capability.
- Varied section options.
- Wide colour choice.



EZIFOLD 6000

Ezifold 6000's flexibility makes it suitable for both commercial and residential projects where large opening apertures are required, with the system maximising light and space to give unimpeded views. This highly-versatile, easy-to-operate system is the perfect option for even the largest project, capable of opening up an entire wall, yet presenting a contemporary, elegant glazed façade when closed.

With high-security glazing, robust locking mechanisms (including multi-point locks on the main opening sashes, and shoot-bolts on the floating mullions), an unrivaled colour range and the option of colour-matched accessories, the system can be tailored to meet each project's specific requirements.



Dual colour & special finishes are available on these doors

Delivering the perfect combination of strength and performance, Ezifold 6000 profiles feature a polyamide thermal break that enhances the system's thermal performance as well as high-quality EPDM gaskets and weather brushes to aid weather resistance. Fully compliant with the requirements of Building Regulations Document L 2010, the doors have the option of either low thresholds for unimpeded, easy access, or rebated thresholds that offer improved weather resistance.

The system features a choice of internally or externally folding sashes, which when open, sit flush to the frame. Sashes are hung from a floating mullion and slide on a recessed bottom roller and top guide, which allow ultra-slim profiles, smooth operation and robust security.

Maximum height 2200mm

Maximum width 1000mm

Sight-lines of 94mm

Frame width 88mm

Maximum weight 100KG per panel

U Value 1.5W/m²K

Air Class 2, 450Pa

Water Class 8A, 450Pa

Wind Class 3, 1200Pa

Intermediate doors have concealed shoot bolt locking with single point handle. Key locking optional

Option for access from outside on any configuration

Every conceivable configuration achievable up to a maximum 7 left 7 right with bottom rolling

Opening either in or out using the same profiles.

EZIFOLD 1000 SLIM

Maximum height 2500mm

Maximum width 1200mm

Sight-lines of 122mm

Frame depth 70mm

Maximum weight 100KG per panel

U Value 1.5W/m²K

Air Class 4, 600Pa

Water Class E, 750Pa

Wind Class 4, 1800Pa

Intermediate doors have concealed shoot bolt locking with single point handle. Key locking optional

Option for access from outside on any configuration

Every conceivable configuration achievable up to a maximum 7 left 7 right with bottom rolling

Opening either in or out using the same profiles.

Ezifold's new 1000 Slim system is the latest addition to our range, delivering a range of benefits for the fabricator, installer and end user.

Featuring new slimmer profiles, the sight-lines of Ezifold 1000 slim have been reduced by 10mm to 122mm, to make the glazed area even larger, an important consideration for projects both large and small.

For installers, the Ezifold 1000 Slim includes the new, Quick-Glaze Bead system featuring an integrated gasket which are simply tapped-in on site, without the need to use a wedge gasket, making the installation and glazing process faster, more straightforward and more cost effective.

Note, DV220G & DV221G sashes when used with UN3160G Quick Glazed Bead are suitable for 28.8mm glazing only.



Dual colour & special finishes are available on these doors

6000 PROFILE

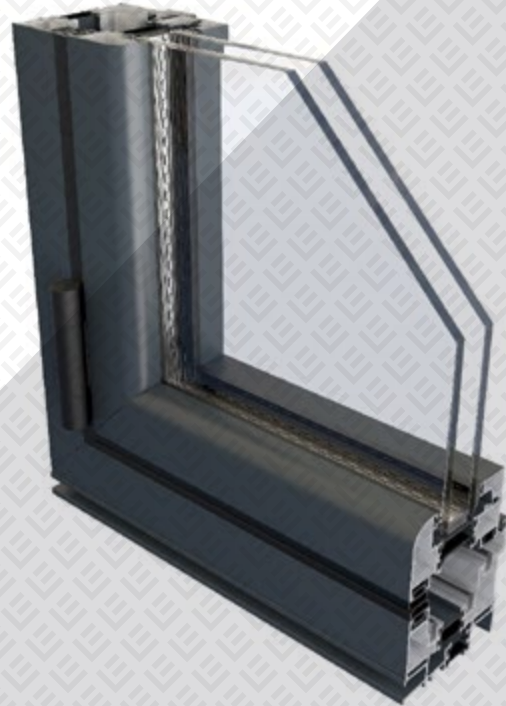

Profile section

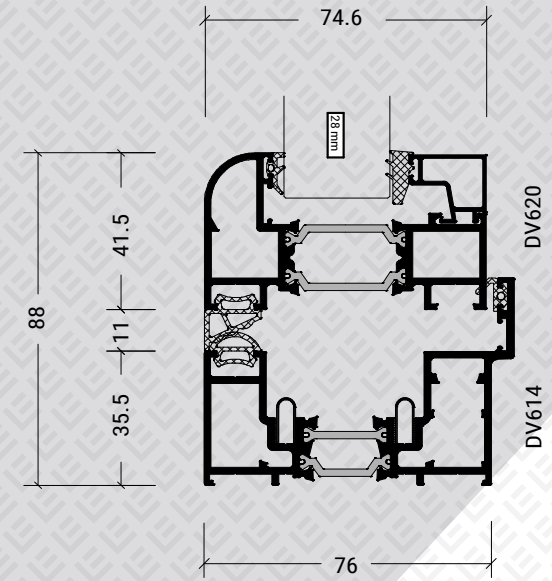

Stile cross-section

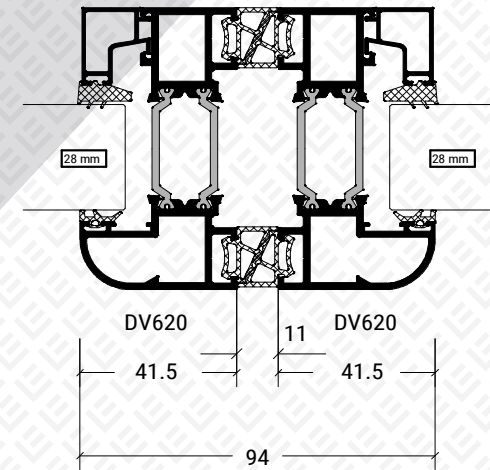

1000 SLIM PROFILE

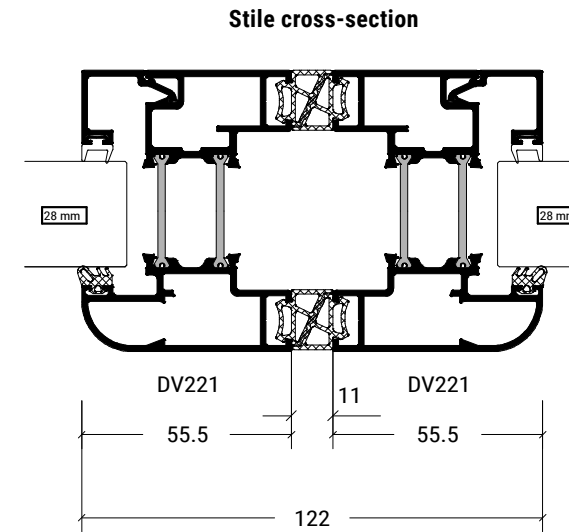
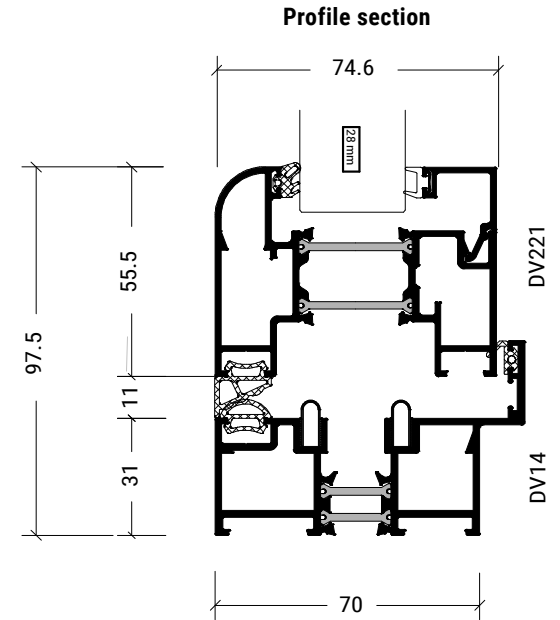

EZIFOLD HERITAGE

Our Heritage bi-fold door design, a high-quality, high-performance, sliding folding door, developed to match the slim profiles and Art Deco design of traditional steel doors. Providing a modern, like-for-like replacement for steel materials, Ezifold Heritage delivers the exceptional thermal performance associated with modern aluminium systems.



Maximum height 2200mm

Maximum width 1000mm

Sight-lines of 94mm

Frame width 88mm

Maximum weight 100KG per panel

U Value 1.5W/m²K

Air Class 2, 450Pa

Water Class 8A, 450Pa

Wind Class 3, 1200Pa

Intermediate doors have concealed shoot bolt locking with single point handle. Key locking optional

Option for access from outside on any configuration

Every conceivable configuration achievable up to a maximum 7 left 7 right with bottom rolling

Opening either in or out using the same profiles.

HERITAGE PROFILE



Glass to glass sight-lines

The Ezifold Heritage bi-folding door boosts sight-lines of just 94mm between doors, glass to glass. This is one of, if not the slimmest in the market. Slim sight-lines, give rise to bigger glass panes, allowing floods of light into the property. Performance is un-compromised with U-Values of 1.5W/m²K, when used with 1.0W/m²K centre panes glazing.



Profile section

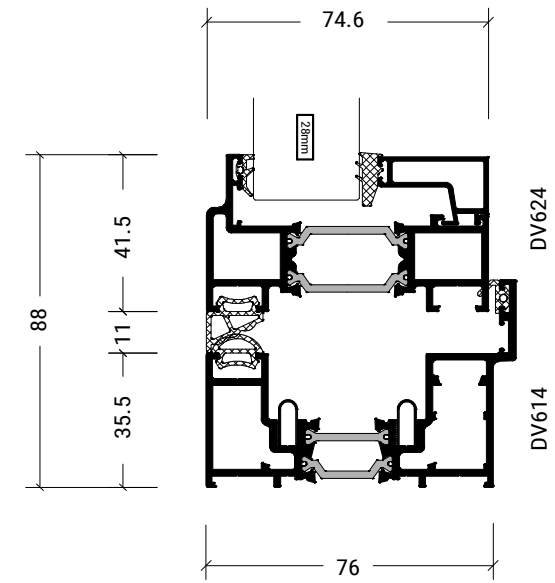

Stile cross-section

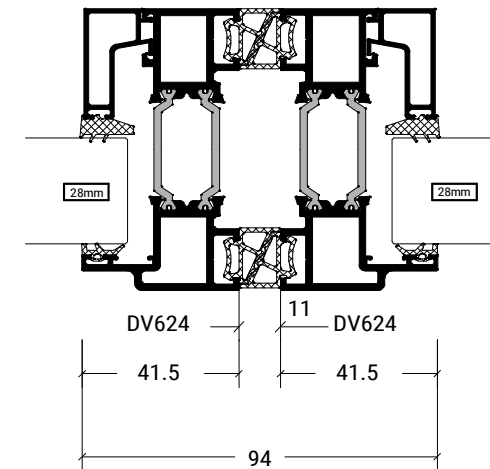



Options & Configurations

The Ezifold Heritage 6000 system is available in a range of configurations to best suit your project. Our most popular bi-fold doors are 3, 4 and 5 panels.

Door widths can be up to 1000mm per panel and up to 2200mm in height. We can offer a range of glazing options for your doors, including laminated security glass, solar glazing and integral blinds.

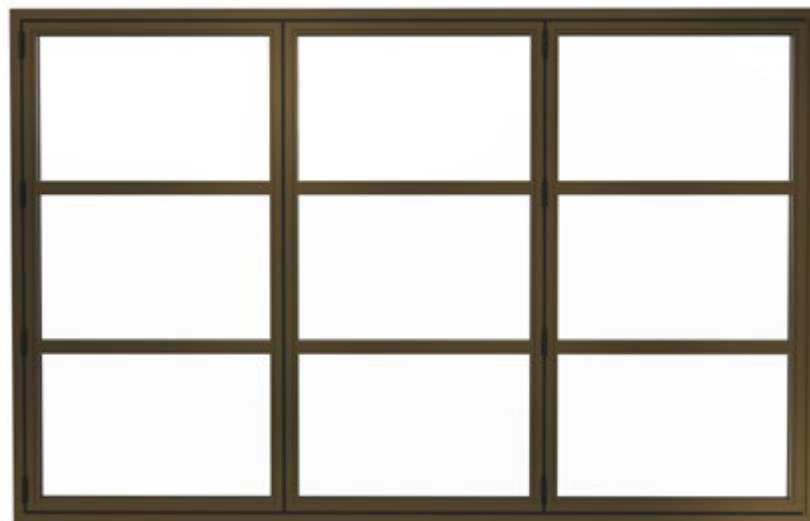

EZIFOLD



BI-FOLD DOOR SYSTEM 12



COLOURS & FINISHES

We have over 150 different RAL colours to choose from, so you can be sure you'll find a colour that suits you. As you would expect from the current generation of bi-folding doors, the aluminium Ezifold bi-folding door by Chigwell Window Centre, offers the full range of powder coated finishes as well as dual colour and specialist powder coat availability.

Our bi-fold doors are powder coated in the standard colours of the Classic RAL System. RAL, the European colour standard system, is used in industry, architecture and construction applications. It defines the industry standard for aluminium coatings and is the most popular European colour standard in today's market. Our bi-folding doors are available in a multitude of all RAL colours and also dual colours so you can have one colour for outside and a different colour for inside.

The most popular bi-fold door RAL colours are

- Black – RAL 9005
- Anthracite Grey – RAL 7016
- White – RAL 9016

Although there are around 150+ colours listed on the RAL chart that cover the whole spectrum.

Gloss or matt finishes can be applied, depending on personal requirements and we keep grey, black and white in stock to ensure a fast turnaround when an order has been placed.

If you require further information on bi-fold door RAL colours or on any other aspect of bi-fold door installation, please do not hesitate to contact us, we are always happy to help.

Popular colours are

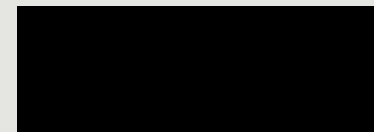

Black – RAL 9005

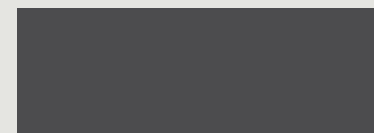

Anthracite Grey – RAL 7016



White – RAL 9016

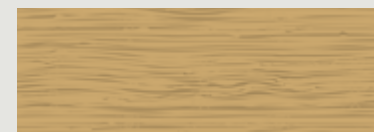

Woodgrain – Light Oak

DUAL
COLOUR
OPTIONS

DUAL
COLOUR
OPTIONS

CUSTOM MADE FOR YOU

Manufactured for your individual needs.



All of our bi-fold doors are bespoke and custom made to your requirements.

Ranging from one through to 14 door sashes, and with door leaves as narrow as 400mm, as wide as 1200mm and as tall as 2500mm, there is a configuration available guaranteed to match your needs.

Just choose your overall size, number of doors, configuration, internal and external colour, your preferred threshold option, whether you want the doors to open in or out, handle style and colour, then let us create your Ezifold door. Ezifold offers above ground bottom running with multiple

threshold options. The hardware components and system are bespoke and designed to give maximum carry capacity, whilst offering slim sight-lines, oversized doors and minimum profiles.

Our Ezifold doors can open in or out using the same profiles, the sash and outer frame are both the same depth and it gives excellent thermal values.

It is a truly in-line system with bespoke hardware resulting in a high performance and very desirable attractive door.



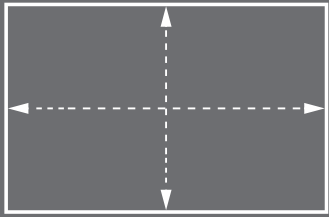

Overall size

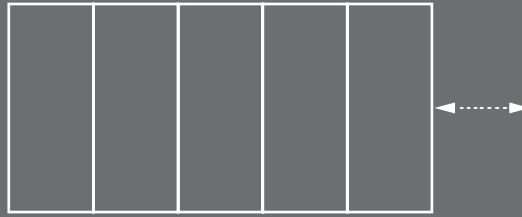

Number of panels

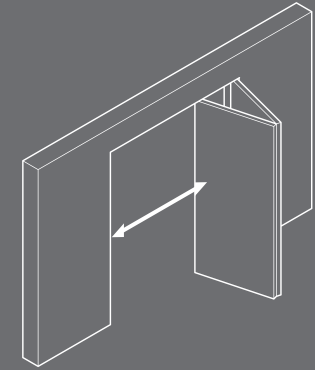

Configuration

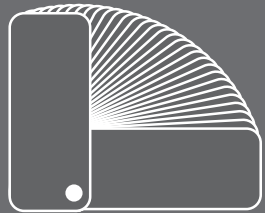

Multiple colours and one or dual colour available

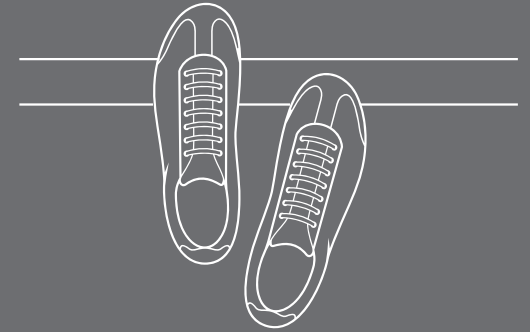

Door thresholds



Guarantees

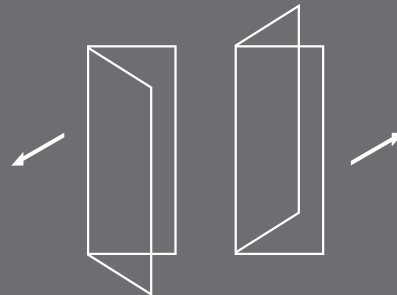

Door openings in / out



Delivered, direct to you

DOOR THRESHOLDS

Now you've chosen how you want your doors to open, you can decide how you would like your threshold to be. Would you like it flush with the floor? Are you happy to have a step over? Most people prefer to keep the threshold as low as possible minimising the divide between the inside and the outside.

We recommend a rebated threshold where the internal floor can be made flush.

Doors that lead into a garden that have a tendency to flood in extreme weather conditions usually have the standard fully weather rated threshold with the step over. This gives an extra 75mm from the ground level before water could get in.

Another option is the low threshold, this isn't weather rated and in extreme weather conditions, some water or wind could penetrate through.

This is suitable for bi-fold doors that are quite well protected and sometimes even sheltered. They also tend to have guttering along the front of the threshold as an added security measure. The low threshold is much easier to install with the low finish, however the standard threshold can be sunk into the floor to create the same low, even flush finish.

Whatever your choice, we will manufacture your bi-fold doors to suit.

Standard threshold



DV176

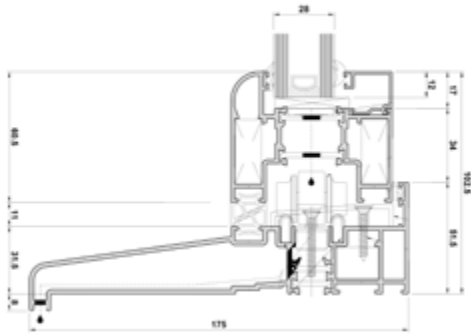

DV271

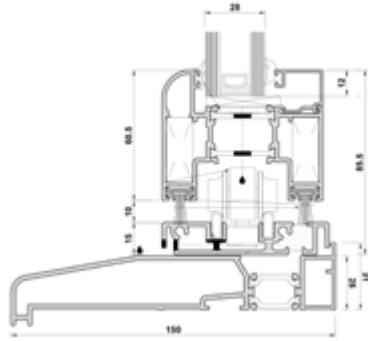

DV14

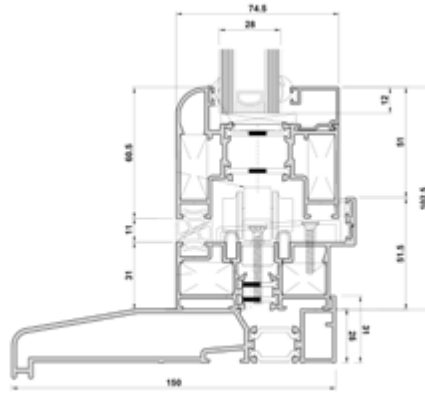

DV17

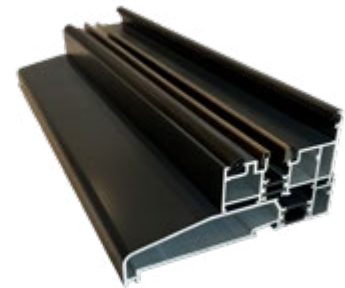
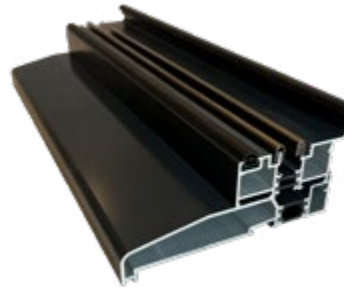
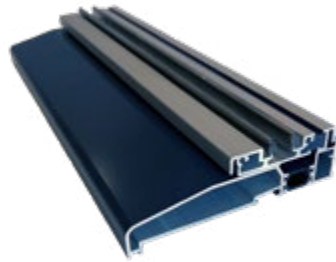
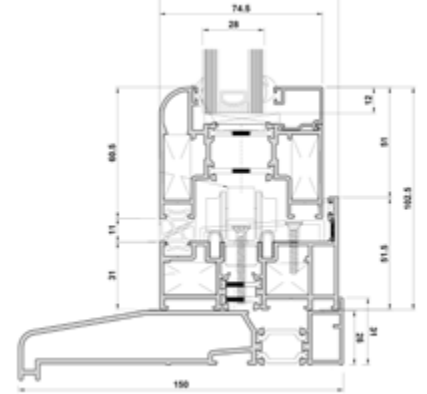

SAFE & SECURE

Because of the importance of security, it is always a major design priority for our Ezifold bi-fold doors.



Our locks are operable and lockable from inside or outside, on any configuration of bi-fold doors. The gearbox is engineered from die cast zinc and the lock constructed from steel – for a corrosion-protected and durable solution.

The Ezifold gearbox/steel bi fold door lock is designed to be concealed within the profile of the door. When the single handle is turned the shoot bolts extend 23mm at the top and bottom of the door to secure the door to the outer frame. Where no key or cylinder is required handles with no escutcheon can be used.

Our lock can allow any configuration of bi-folding door to have access from both inside and out. This is especially useful when configurations with no swing panel/access door are incorporated in the arrangement. End users are able to have a handle on the exterior of the door in any configurations. Handles on both sides of the door have threaded screw points for M5 screws. These meet in the centre of the gearbox/lock along with the spindle.

We stock a selection of special length screws for a perfect fit. Applying medium strength thread lock fluid will ensure all handles remains secure for the whole of life, preventing loose handles occurring from regular use.

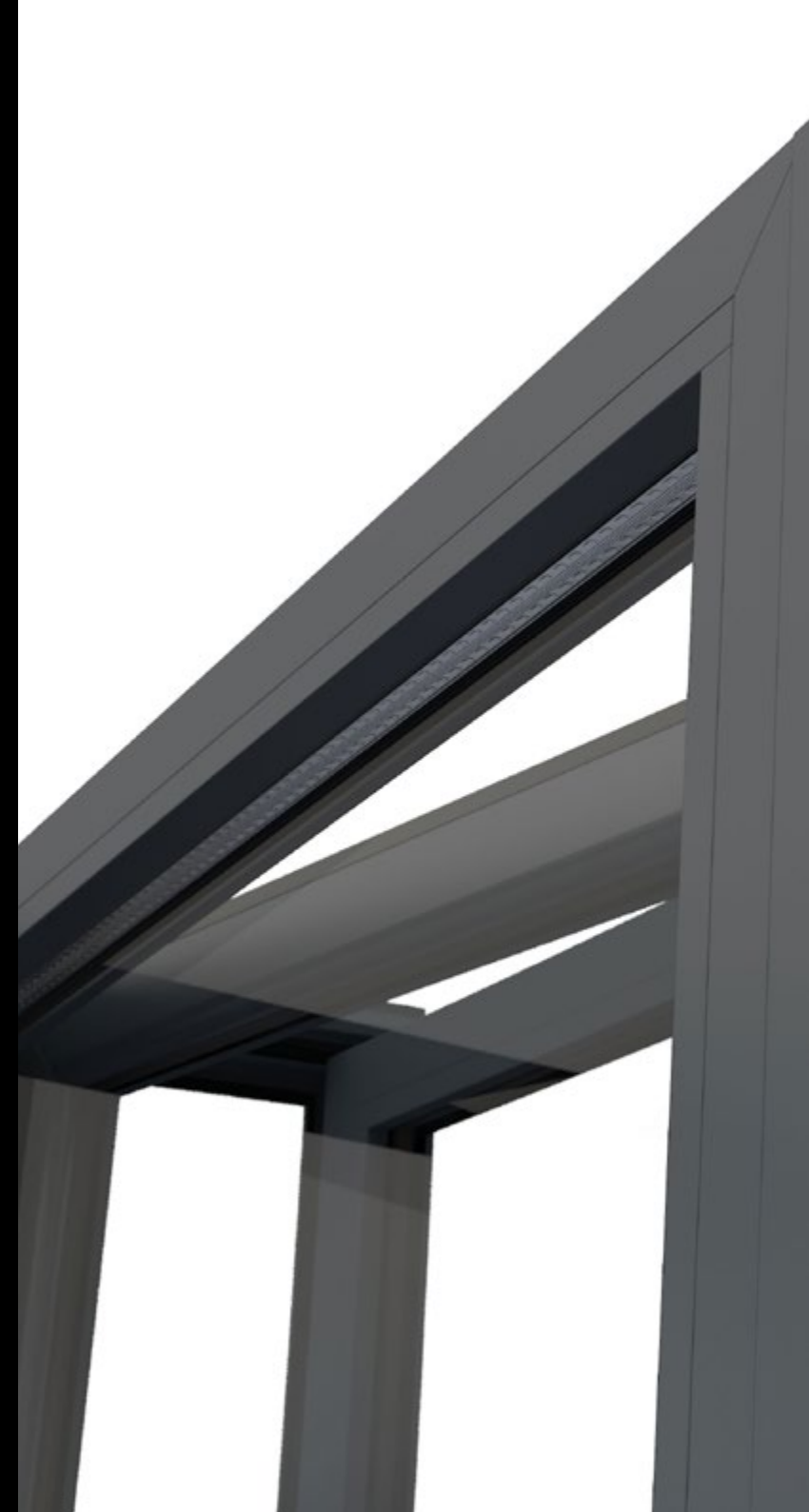



The Lock...

We're proud of our outstandingly secure and completely unique multi-point locking system which conforms to all the latest security standards including PAS 24:2016.



Our unique multi-point locking system offers an incredibly performance and ensures your home is kept safe and secure. Chamfered 20mm linear bolts offer a smoother operation when engaging the lock, as well as giving maximum compression for increased weather resistance. Add deep throw 25mm security hooks – the deepest engagement available on the market today – and the lock delivers the best in both security and weatherproofing.

Barrel Options...

Ezifold is fitted with a 3-Star Diamond, British Standard Kitemark locking barrel as standard.



These barrels are proven to protect against snapping, picking, drilling and bumping, offering a defence that is second to none.

Other Security Features...

On both systems, we have specifically designed hinges that are engineered to help withstand attacks, offering little opportunity for even the most determined intruder. All of this, on top of the innately robust and strong aluminium profile, makes for two ultra-secure systems.



DOOR HANDLES



The handles are used constantly, without a second thought, so the handles on a bi-fold door have to be strong and reliable and ready to withstand the years of use that they will receive.

Our Ezifold bi-fold door handles are made with our customary care and dedication; our handles are modern, with elegant styling whilst mixing a balance between their strength, sleek design and flawless functionality.

The handles are available in brushed aluminium, chrome, white and black.

FABRICATION

Our line up of specialist equipment includes the AL220 cutting and machining centre, capable of handling all sawing, milling, drilling and marking operations on a single platform.

Thanks to an intelligent computer control system and powerful servo motors, it can work quickly and precisely, and is easily operated with a 15-inch touch screen. It enables us to make more outstanding aluminium bi-fold doors, even more quickly and efficiently. By purchasing a whole array of state-of-the-art manufacturing equipment, we've quickly been able to become a ground-breaking business in British fenestration. When you order your Ezifold bi-fold doors you won't be waiting for ages for your delivery thanks to our continued investment in state-of-the-art machinery to help maintain our signature speedy lead times.





EZIFOLD

Bi-fold door range

6000 | 1000 SLIM | HERITAGE

chigwellwindowcentre.co.uk | 020 8500 4900 | sales@chigwellgroup.co.uk



Chigwell
WINDOW CENTRE
PART OF THE CHIGWELL GROUP